

263253600

VAMPYR® 831 i electronic

AEG

Bodenstaubsauger

Cylinder vacuum cleaner

Aspirateur-traîneau

Stofzuiger, sledemodel

Aspirapolvere da pavimento

Gebrauchsanweisung

Operating instructions

Mode d'emploi

Gebruiksaanwijzing

Istruzioni per l'uso

AUS
ERFAHRUNG
GUT

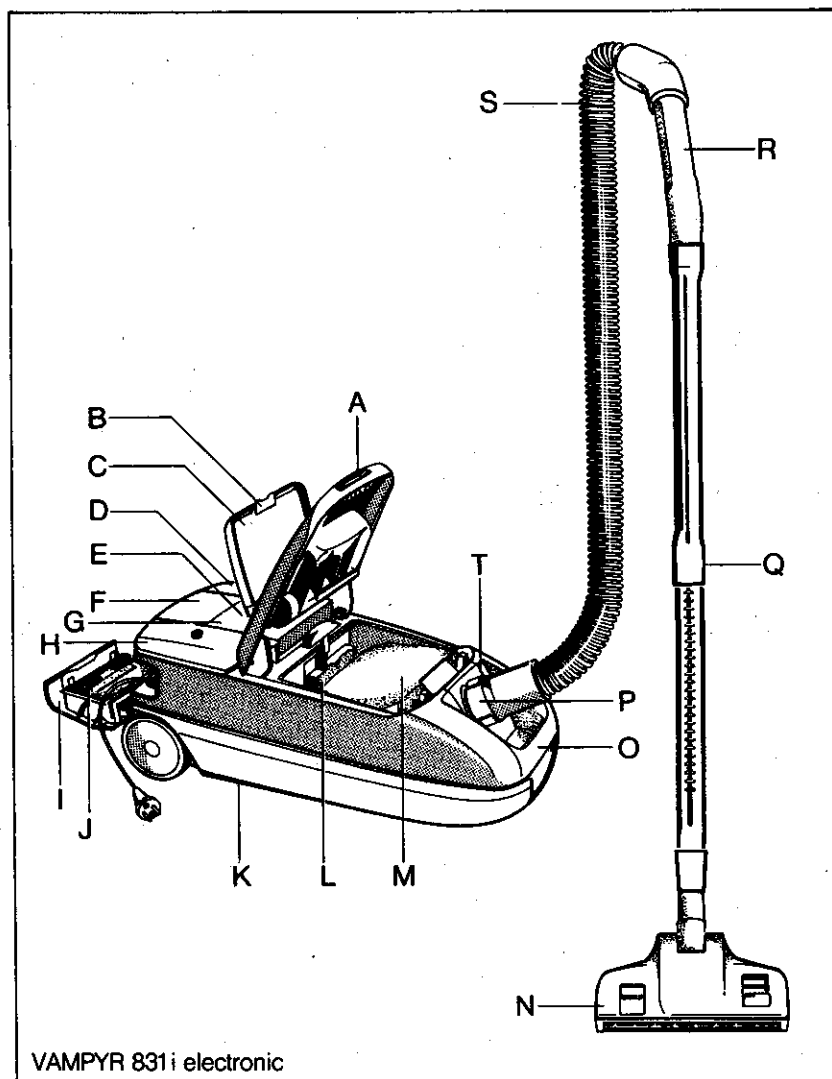

VAMPYR 831i electronic

- | | |
|--|--|
| A = Opening button for paper dustbag compartment | K = Storage rail |
| B = Button for accessories compartment | L = Motor-protection filter |
| C = Accessories compartment | M = Paper dustbag |
| D = On/Off button | N = Floor cleaning head |
| E = Micro-filter change indicator | O = Carrying handle |
| F = Electronic power control | P = Button for suction hose removal |
| G = Dustbag full indicator | Q = Telescopic tube |
| H = Foot-operated flex rewind button | R = Handle |
| I = Micro-filter cassette | S = Suction hose |
| J = Micro-filter | T = Socket for electric, power cleaning head |

Contents

Description of appliance	14
Before using the appliance for the first time	16
Safety instructions for the user	16/17
Assembling the vacuum-cleaner ready for use	
Fitting suction hose and tube/s together	18
Suction tube/Telescopic tube	18
Connecting suction hose	18
Mains connection/Flex rewind	19
Using the floor cleaning head & accessory nozzles	
Using the floor cleaning head	19
Accessory nozzles	19/20
Switching on and adjusting	
Switching on	21
Adjusting power	21
Maintenance	
Changing the paper dustbag	22
Changing the micro-filter	23
Motor protection filter	23
Transportation and storage	24
What do I do if...?	24/25
Special accessories	26
For the sake of the environment	27
AEG Service Centres in Europe	64



Before using the appliance for the first time

Please read all the information contained in this booklet. It gives you important instructions on safety, use, and maintenance of the appliance. Please keep these instructions in a safe place and pass them on, if necessary, to the next owner.

Safety instructions for the user

- This appliance meets the radio interference suppression requirements of EC Directive 82/499 EC and 87/308 EG, EN 55014/DIN VDE 0875 Part 1, as well as the standards concerning the reverse effects of electrical appliances on the power mains EN 60 555 Parts 1-3/DIN VDE 0838 Parts 1-3, of June 1987.
- This appliance must only be connected to the same mains voltage as shown on the rating plate.
- The circuit of the socket used must be protected with a fuse of at least 13 A.
- Before maintenance or cleaning, ensure that the appliance is switched off and unplugged from the mains supply.
- Never use the flex to pull the mains plug out of the plug socket.
- Do not operate the appliance if:
 - the flex is damaged
 - the housing shows visible signs of damage.
- Avoid running over the flex with the appliance, cleaning head or electric power cleaning head.
- **If no paper dustbag is inserted the cover cannot be closed. Please do not use force!**
- Make sure a paper dustbag, a MICROFILTER, and a motor protection filter are always inserted.
- This vacuum cleaner should only be used for normal dry household dust and dirt. It must not be used on people or animals.
Keep children away from electrical appliances.
The manufacturer cannot be held responsible for any damage caused by use or operation of the appliance contrary to these instructions.
- Allow fitted carpets that have been shampooed to dry out completely. Never use your vacuum cleaner to vacuum liquids, otherwise it may be damaged. There is also a risk of an electric shock.
- Never use your appliance to vacuum matches, glowing embers, or cigarette-ends. Avoid vacuuming hard, pointed objects, since they may damage the appliance or paper dustbag.
- If the flex is defective, the complete flex rewind unit should be replaced by your AEG Service Centre or an authorised AEG Service Agent.
- Repairs to electrical appliances should only be carried out by a trained electrician. Improper repairs may place the user at serious risk.
- If your vacuum cleaner has a fault, please contact your electrical retailer or the AEG Service Centre direct.
- If the appliance is wrongly operated for a purpose other than that for which it is intended, no liability can be accepted for any possible damage.

Important for users in the UK

The wires in the mains lead of this appliance are coloured in accordance with the following code:

BLUE – neutral **BROWN – live**

As the colours of the wires in the mains lead of this appliance may not correspond with the coloured markings identifying the terminals in your plug, **PROCEED AS FOLLOWS:**

The wire which is coloured **BROWN** must be connected to the terminal which is marked **L** or coloured **RED**.

The wire which is coloured **BLUE** must be connected to the terminal which is marked **N** or coloured **BLACK!**

If a 13 amp plug is fitted, fit a 13 amp BS1362 fuse. If any other type of plug is used, protect with a 15 amp fuse at the distribution board.

For appliances which come with mains lead and plug moulded on: the plug moulded on to the cord incorporates a fuse. For replacement use a 13 amp BS 1362 fuse. Only ASTA approved or certified fuses should be used. The fuse cover/carrier must be replaced in the event of changing the fuse. The plug must not be used if the fuse cover/carrier is lost. A replacement cover/carrier must be obtained from authorised electrical goods retailers.

WARNING

Should it become necessary to replace the moulded on plug then the defective plug should be destroyed.

Assembling the vacuum-cleaner ready for use

The hose, tubes and accessories can be fitted together by pushing and twisting, and taken apart by twisting and pulling.

Fitting the suction hose and suction tube together

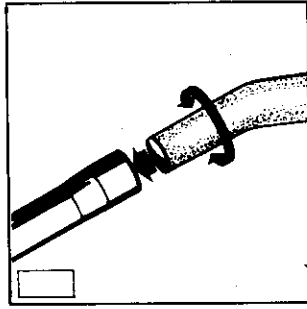

Push the tube end of the hose firmly into the suction tube.

Adjusting the telescopic tube

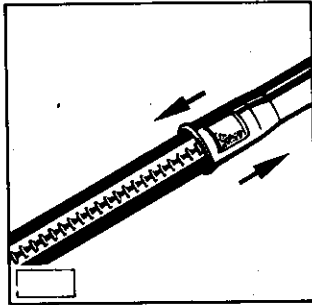

Slide the button on the tube downwards and set the tube at the most convenient length for working with. When the button is released the telescopic tube is engaged in the position you require.

Connecting the suction hose

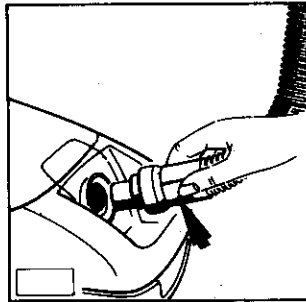

Insert the hose holder into the suction opening. When the hose is to be disconnected from the appliance, press the release button and pull the hose holder out of the suction opening.

Mains connection/Flex rewind

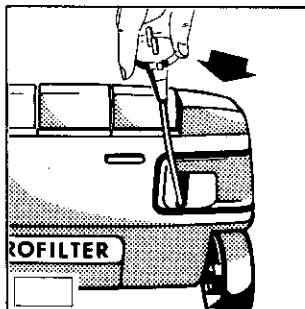

The mains cable is located in the cable compartment. Press the foot button for the cable, and pull the cable out. Insert the plug into the socket. At the end of vacuuming switch off and pull the plug out of the socket. Press the flex rewind button and the cable rewinds automatically.

Using the cleaning head and accessory nozzles

The cleaning head and nozzles are attached to the suction tube by pushing and twisting, and taken apart again by twisting and pulling.

Using the floor cleaning head

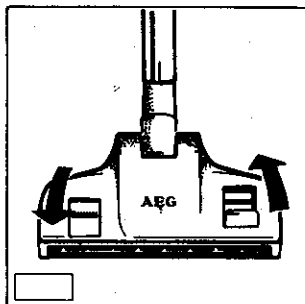

For care of carpets and hard floors, the cleaning head can be adjusted to suit the type of floor with your foot:

for carpets



Symbol for carpet, brush withdrawn

for hard floors



Symbol for hard floor, brush extended

For other optional extra floor cleaning heads see Special Accessories.

Accessory Nozzles – Furniture Brush, Crevice and Upholstery Nozzles

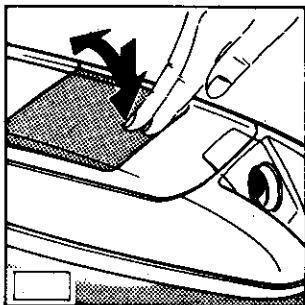

The integrated accessories compartment contains 3 nozzles – a furniture brush, a crevice nozzle and a upholstery nozzle. Open the compartment by pressing lightly on the cover as shown in the illustration.

Dusting Brush

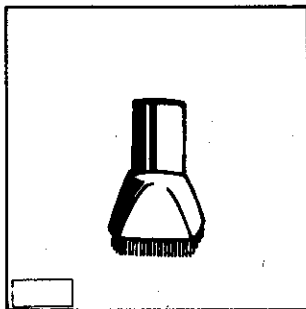

For gentle vacuuming of delicate fabrics and objects, i.e. curtains, furniture, books, pictures etc.

Crevice Nozzle

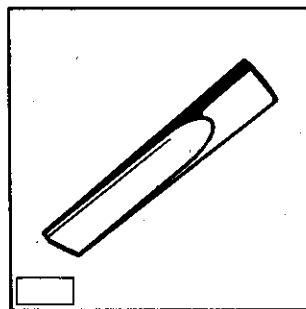

For vacuuming in those normally inaccessible places i.e. reaching cobwebs, or down the side of a sofa!

Upholstery Nozzle

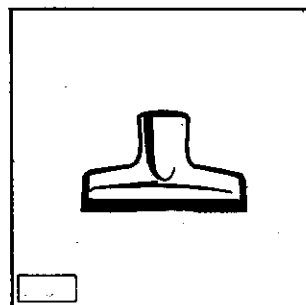

For vacuuming upholstery, mattresses, etc. The thread collectors help to pick up the threads and fluff.

Switching on and adjusting

Switching on



Press the On/Off-button to switch the vacuum cleaner on or off.

Adjusting power – foot controls

The vacuuming power can be adjusted to suit any situation with the electronic power control.



250 W = For delicate fabrics, e.g. net curtains, upholstery



650 W = Economy setting for light to normally soiled carpets



max = For hard floors and heavily soiled carpets

If by accident you press two buttons at once, the appliance operates at the higher output. If the appliance is switched on and none of the three buttons are pressed, it will always work at the lowest output i.e. 250 W.

Maintenance

Changing the paper dustbag

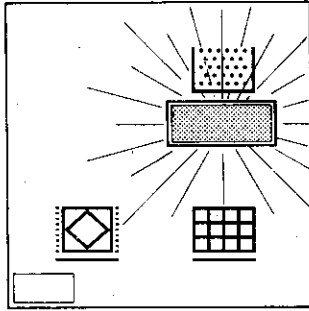

Switch off and pull out the mains plug before changing the dustbag.

Changing the paper dustbag is necessary when the dustbag full indicator light comes on. We recommend changing the dustbag even when it does not appear to be full, but the indicator light still comes on, this could indicate that there is a high proportion of very fine dust present.

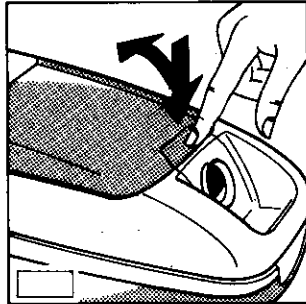

Open the cover by pressing the button, and lifting it up until it snaps into place.

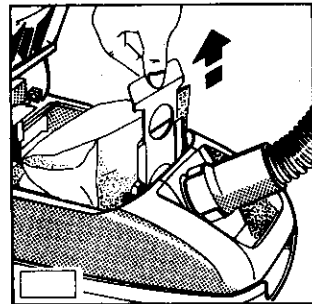

Hygienic dustbag change: when you take out the full dustbag, you automatically cover the opening by pulling on the closure tag. You may have to overcome a slight resistance as you pull. Full dustbags can be disposed of with the normal household rubbish.

Push the new dustbag into the guide rails as far as it will go, only then will the cover close. If no dustbag is inserted the cover cannot be shut. Please do not use force!

Paper dustbag sizes

Please use original AEG dustbags, **Size 23**, or dustbags which carry the AEG Quality Seal. They are available from electrical retailers under the order-number E 618 899 683, or from the AEG Service Centre under ET-No. 668 901 263. Damage resulting from the use of any other dustbag is not covered by the Guarantee.

Changing the micro-filter

Switch off and pull out the mains plug before changing the micro-filter.
Changing the micro-filter is necessary:

For appliances with no micro-filter indicator – when the dustbag full indicator lights up, even when a clean dustbag has been inserted, with the appliance switched on, hold the head/nozzle upwards or off the floor, if the light remains on, this indicates the micro-filter should be changed. We recommend changing the micro-filter with every fifth bag.

For appliances with micro-filter indicator – when this comes on.

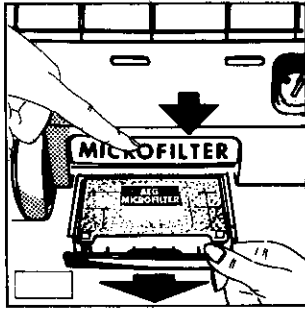

The cassette can be opened by pressing the micro-filter button. Take out the cassette in the direction of the arrow and empty the micro-filter over a dustbin – this avoids you touching the dirty micro-filter.

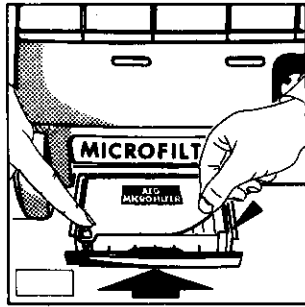

Insert the new micro-filter into the cassette as shown in the illustration, push it back in parallel to the floor, and snap the cover shut.

Motor protection filter

The motor protection filter is a permanent filter and does not have to be changed regularly. Exception: if it has been damaged. See "What to do if . . .".

Cleaning the dustbag compartment

As and when necessary wipe the dustbag compartment with a damp cloth.

Transportation and storage

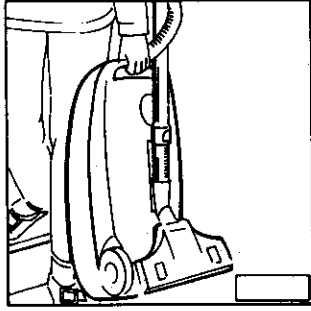

For easier storage and for transporting the appliance, slide the floor cleaning head or the ROTOSOFT 1000 Turbo-brush into the storage rail.

What to do when ...

... the motor protection is activated?

When the paper dustbag is full or blocked or any of the accessories are blocked the over-heating protection for the motor is activated. Switch off and unplug the vacuum cleaner and allow the motor to cool down. Check the paper dustbag and accessories and remove any blockages. The cleaner can be switched on again after 30 minutes.

... the fuse blows or trips?

If you connect other electrical appliances with a high wattage to the same mains circuit and use them at the same time as the vacuum cleaner, this can trip the fuse. This can be avoided if you set the electronic power control to 250 W before you switch on, and only select a higher output level after switching on.

... the thread-collectors are worn out?

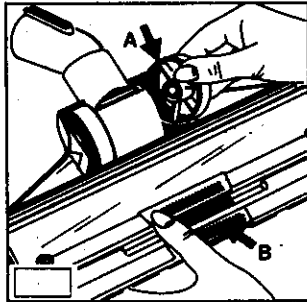

If the thread-collectors (B) at the suction opening are worn out or stuck together, you can fit ones. They can be ordered from the AEG Service Centre under the ET-No. 668 900 560.

... the wheels of the floor cleaning head are hard to move?

Remove any hairs or threads which have become wrapped round the axle of the roller. The wheels can be removed for cleaning. Pull roller (A) as illustrated. Remove hairs and threads. When replacing it, the semi-circular axle-head must point inwards. If the roller axle is inserted wrong way round the swivel joint could suffer damage.

... the paper dustbag has been damaged and there is dirt in the motor protection filter?

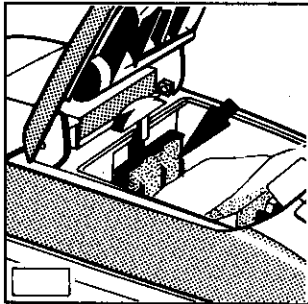

Remove the motor protection filter, clean it (by shaking the dirt out), and re-insert it.

... the lid comes out of the hinge?

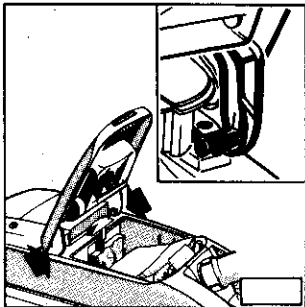

If the lid of the vacuum cleaner has been opened too far, beyond the stop, and comes out of the hinge, place it back on the housing and press it down until it clicks into place.

Special accessories

ROTOSOFT 1000 turbo-brush

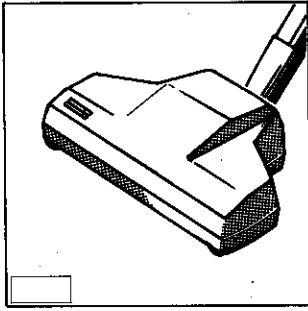

The ROTOSOFT 1000 makes the care of carpets and hard floors easier. The rotary motion of its brush gently loosens shortpile carpets where the dirt has been trodden in.

ROTOSOFT 3000 electric cleaning head

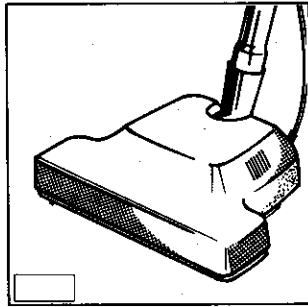

For all AEG vacuum-cleaners with socket. For cleaning difficult carpet conditions. This cleaning head deals very effectively with difficult carpet conditions. Its rotating brush picks up trodden-in dirt and straightens the carpet pile.

Radiator brush

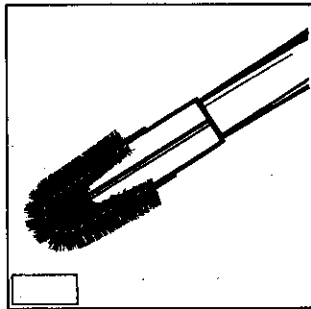

For dusting between the ribs of radiators, between shelves, or in other narrow gaps. Attach to crevice nozzle.

For the sake of the environment

Please do not simply throw away the packaging material, or old appliances that have served their time.

Appliance packaging:

- The cardboard carton can be sent to the waste-paper collection.
- The polyethylene plastic bag can go to the plastic collection-point for recycling.

Recycling the appliance at the end of its life:

- The plastic parts are identified with numbers so that they can be sent for recycling when the appliance is taken out of service.

Please ask your municipal authority where the local recycling collection-points are.

AEG Kundendienst in Europa

W-1000 Berlin 33, Hohenzollerndamm 150
W-2000 Hamburg-Bahrenfeld, Holstenkamp 42
W-2300 Kiel, Rendsburger Landstraße 206
W-2800 Bremen, Hastedter Osterdeich 222
W-3000 Hannover 1, Max-Müller-Str. 50-56
W-3300 Braunschweig, Campestraße 7
W-3500 Kassel-Waldau, Otto-Hahn-Straße 5
W-4000 Düsseldorf (Kundendienst in W-4047 Dormagen)
W-4047 Dormagen-St. Peter, Sachtlebenstraße 1
W-4300 Essen-Altenessen, Teilungsweg 28
W-4400 Münster, Friedrich-Ebert-Straße 7
W-4500 Osnabrück, Pferdstraße 23
W-4600 Dortmund, Rheinlanddamm, AEG Haus
W-4800 Bielefeld, Schillerstraße 44
W-5000 Köln (Kundendienst in W-4047 Dormagen)
W-5100 Aachen, Grüner Weg 22-24
W-5300 Bonn, Friedrich-Ebert-Allee 26
W-5400 Koblenz, Rheinstraße 17
W-5500 Trier, Paulinstraße 152
W-5900 Siegen, Sandstraße 173
W-6000 Frankfurt/Main, Mainzer Landstraße 349
W-6095 Ginsheim-Gustavsburg, Darmstädter Landstraße 47
W-6300 Gießen, Schanzengasse 1-5
W-6400 Fulda, Michael-Henkel-Straße 4-6
W-6502 Mainz-Kostheim,
(Kundendienst in W-6095 Ginsheim-Gustavsburg)
W-6600 Saarbrücken-St. Johann, Mainzer Straße 176
W-6750 Kaiserslautern, Jägerstraße 10-12
W-6800 Mannheim-Käfertal, Heppenheimer Str. 31-33
W-7000 Stuttgart (Kundendienst in W-7030 Böblingen)
W-7030 Böblingen-Hulb, Dornierstraße 7
W-7100 Heilbronn, Weinsberger Straße 18
W-7500 Karlsruhe, Neureuter Straße 5-7

W-7600 Offenburg, Industriestraße 7
W-7800 Freiburg, Tullastraße 84
W-7900 Ulm, Neue Straße 113-115
W-7980 Ravensburg, Henri-Dunant-Straße 6
W-8000 München-Neuhausen, Arnulfstraße 205
W-8200 Rosenheim, Pichlmayrstraße 21
W-8390 Passau, Weinholzer Weg 9
W-8400 Regensburg, Bukarester Straße 12
W-8500 Nürnberg, Muggenhofer Straße 135
W-8670 Hof, Wunsiedler Straße 56
W-8700 Würzburg, Versbacher Straße 22a
W-8750 Schaffenburg, Dammer Straße 5
W-8900 Augsburg-Lechh., Raiffeisenstraße 13
W-8960 Kempten, Brodtkorbweg 22
O-2500 Rostock, Hermann-Dunker-Platz 1
O-5082 Erfurt, Armstädter Straße 28
O-7027 Leipzig, Holzhäuser Straße 120
O-8060 Dresden, an der Eisenbahn/Industriegelände

Österreich, 1232 Wien, (02 22) 8 65 45 10-0
Belgique/België, 1800 Vilvoorde, 02/370.08.98
Danmark, 2620 Albertslund, 42-64 85 22
España, Madrid, (91) 675.66.50/54/58/62
France, 92350 Leplessis Robinson, 45.37.95.59/95
Great Britain, Slough, 07 53-87 25 06
Hellas, Moschaton-Athen, 01/48 22 646
Island, Reykjavik (Brædurinn Ormsson Ltd.) 91-3 88 20
Italia, Cusano Milanino MI 02/6 13 47 60/6 19 76 90
Luxembourg, 1246 Luxembourg-Kirchberg, 43 888-4
Nederland, 1066 BP Amsterdam, 0 20-5 10 59 11
Norge, 2000 Lillestrøm, 06-81 01 01
Portugal, 1799 Lisboa Codex, 89 11 71-89 71 21
Schweiz - Svizzera, 8603 Schwerzenbach 01/945 11 44
Suomi, 01301 Vantaa 30 (Sähköliikkeiden Oy), 90-83 81
Sverige, 17141 Solna, 08-29 00 80

Garantiebedingungen

Für dieses Gerät leisten wir - zusätzlich zu der gesetzlichen Gewährleistung des Händlers aus Kaufvertrag - dem Endabnehmer gegenüber zu den nachstehenden Bedingungen Garantie:

- Die Garantiezeit beträgt 12 Monate und beginnt mit dem Zeitpunkt der Übergabe des Geräts, der durch Rechnung oder andere Unterlagen zu belegen ist. Die Garantiezeit ist auf 6 Monate beschränkt, wenn das Gerät gewerblich genutzt wird.
- Die Garantie umfaßt die Behebung aller innerhalb der Garantiezeit auftretenden Schäden oder Mängel des Geräts, die nachweislich auf Material- oder Fertigungsfehlern beruhen. Nicht unter die Garantie fallen Schäden oder Mängel aus nicht vorschriftsmäßigem Anschluß, unsachgemäßer Handhabung sowie Nichtbeachtung der Gebrauchsanweisungen.
- Im Garantiefall kann das Gerät einer unserer Kundendienst-Stellen oder dem autorisierten Fachhandel übergeben werden.
Bei Einsendung des Geräts an die für Sie zuständige Kundendienststelle ist darauf zu achten, daß das Gerät gut verpackt, mit vollständigem Absender und - soweit möglich - mit einer kurzen Fehlerbeschreibung versehen wird.
- Die Garantieleistungen werden ohne jede Berechnung durchgeführt; sie bewirken weder eine Verlängerung noch einen Neubeginn der Garantiezeit. Ausgewechselte Teile gehen in unser Eigentum über.

Guarantee

This appliance is covered by the following guarantee and is in addition to your statutory and other legal rights. All components which fall due to defective manufacture will be repaired or replaced free of charge for a period of 12 months from the date of purchase. We will not accept claims if unauthorised modification is made or if non-standard components are used. The appliance must be used in accordance with the operating instructions and the guarantee does not cover any damage caused during transit or through misuse. In order to establish the date of purchase, advice note or similar document must be produced whenever the guarantee is claimed.

Garantie

Pour toute mise en œuvre de garantie ou de service après vente, vous devez vous adresser à votre vendeur.
AEG assure au vendeur le remplacement gratuit des pièces détachées nécessaires à la réparation pendant 1 an, à partir de la date de votre facture, sauf en cas de non respect des prescriptions d'utilisation ou lorsqu'une cause étrangère à l'appareil est responsable de la défaillance.
Les dispositions stipulées ci-dessus ne sont pas exclusives du bénéfice au profit de l'acheteur de la garantie légale pour défaut et vice cachés qui s'applique, en tout état de cause, dans les conditions des articles 1641 et suivants, du code civil.

Garantie

AEG Nederland N.V. neemt voor reparaties binnen de garantietermijn - voor zover de defecten zijn terug te voeren op materiaal- en/of constructiefouten - de kosten op zich voor materiaal en arbeidloon.

De garantie bedraagt 12 maanden en gaat in op de dag van aankoop. Wanneer garantie wordt verlangd, dient de faktuur van aankoop te worden overlegd. De garantietermijn wordt door reparaties niet verlengd. Buiten elke garantieverplichting vallen losse onderdelen van glas en/of kunststof. Alle overige kosten, zoals voorrijkosten, kosten van opzending en administratie, zijn voor rekening van de eigenaar.

Garanzia

Duranti i primi 12 mesi d'esercizio, vengono fornite gratuitamente dall'AEG le parti di ricambio riconosciute difettose. La garanzia ha inizio con il giorno dell'acquisto che deve venir comprovato a mezzo della fattura o boletta di consegna. Per il resto valgono le condizioni generali di fornitura della rispettiva rappresentanza nazionale.

Garantía

Durante los primeros 12 meses, la AEG se hace cargo de cuantos costes de material y horas de trabajos invertidas se produzcan en la subsanación de defectos. La garantía empieza a regir a partir de la fecha de la entrega, la que deberá justificarse mediante presentación de la factura o de la nota de despacho. Por lo demás serán de aplicación las condiciones generales de venta de nuestro país de venta se gun rigen en el respectivo país de nuestra representación.

Garantie

In Belgien ist nur die durch S. A. belge AEG ausgegebene Garantiekarte gültig. En Belgique, seule la carte de garantie émise par la S. A. belge AEG est valable. In België is slechts de door de S. A. belge AEG uitgegeven waarborgkaart geldig.

AEG Hausgeräte AG, Muggenhofer Straße 135, D-8500 Nürnberg 80

H 263 253 600 - 0892/02 -